



PROLEĆNI BILTEN 2011



ROŠTILJI



MAŠINE I OPREMA



AVIO OPREMA - AKTIVNI BOJE ZA BETON - EKOLOŠKI PIGMENTI

U slučaju nekih od naših proizvoda koji sadrže avio opremu, potrebno je koristiti posebne pigmente koji omogućuju bojenje betona. Ovi pigmenti su dostupni u različitim bojama i mogu se koristiti za bojenje betona u različitim dijelovima objekta. Za više informacija kontaktirajte našu službu za korisnike.

U slučaju nekih od naših proizvoda koji sadrže avio opremu, potrebno je koristiti posebne pigmente koji omogućuju bojenje betona. Ovi pigmenti su dostupni u različitim bojama i mogu se koristiti za bojenje betona u različitim dijelovima objekta. Za više informacija kontaktirajte našu službu za korisnike.

PRESOVANI PROGRAM

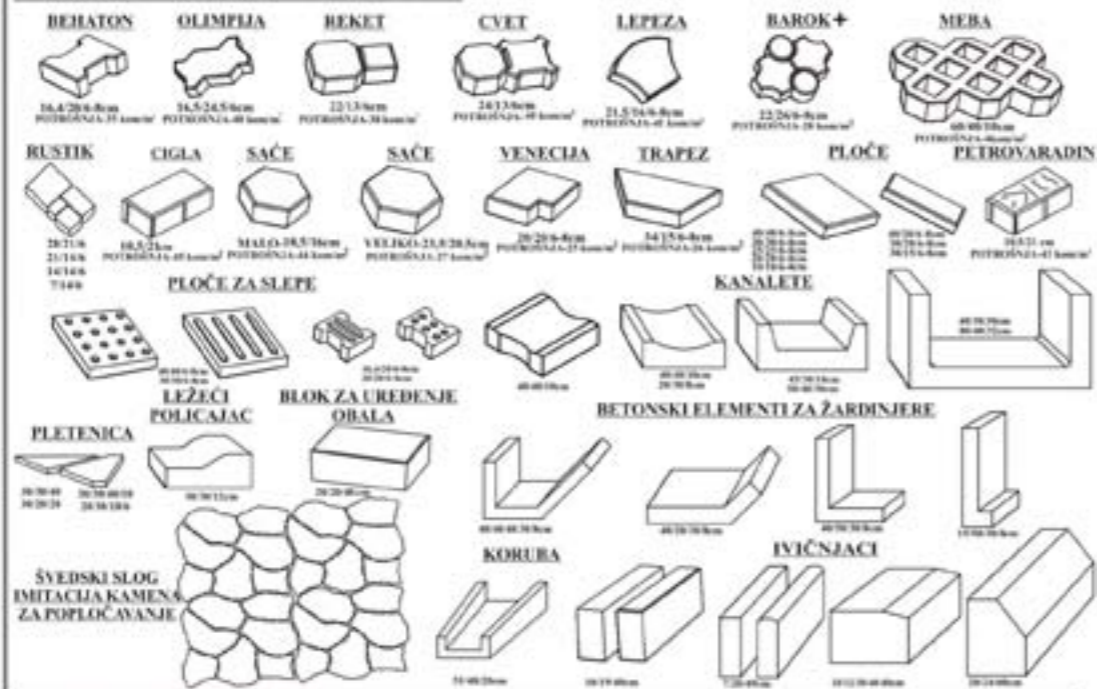

LIVENI PROGRAM

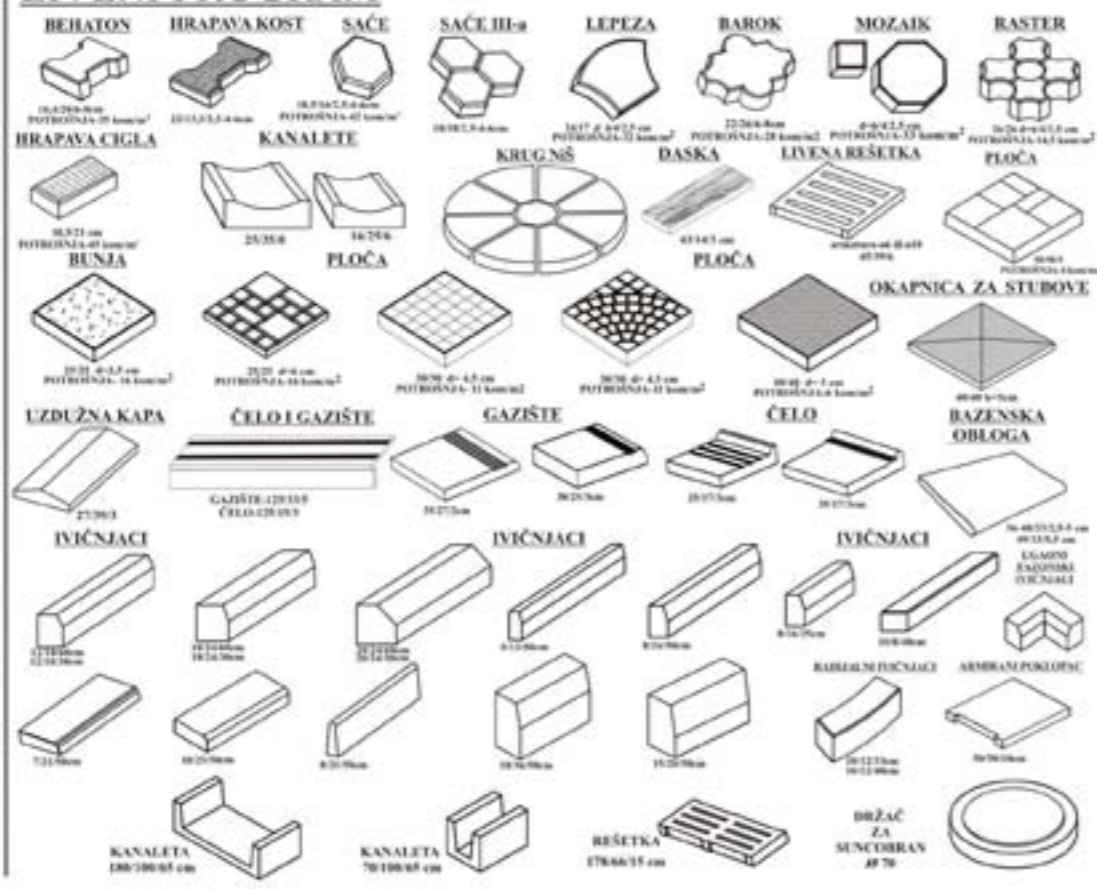

BLOKOVSKA ROBA

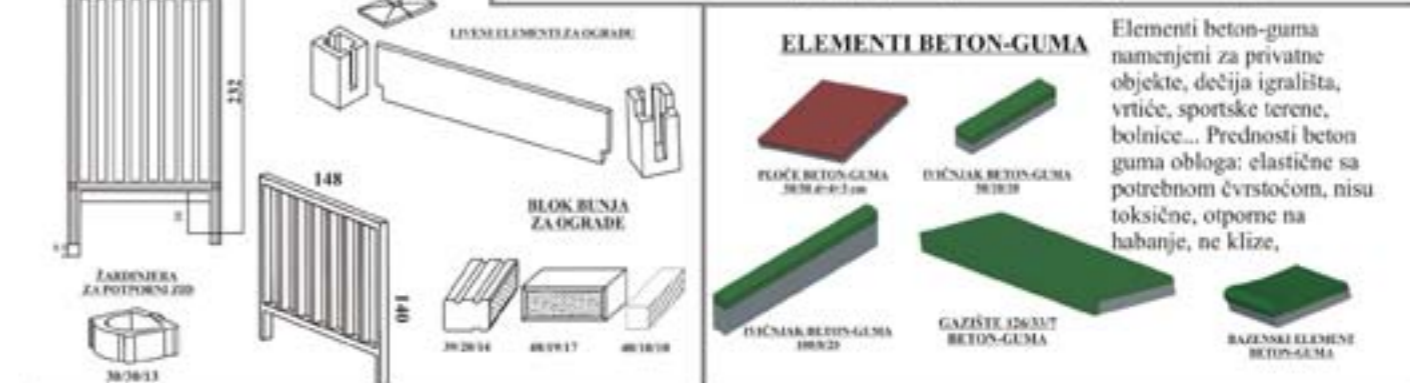
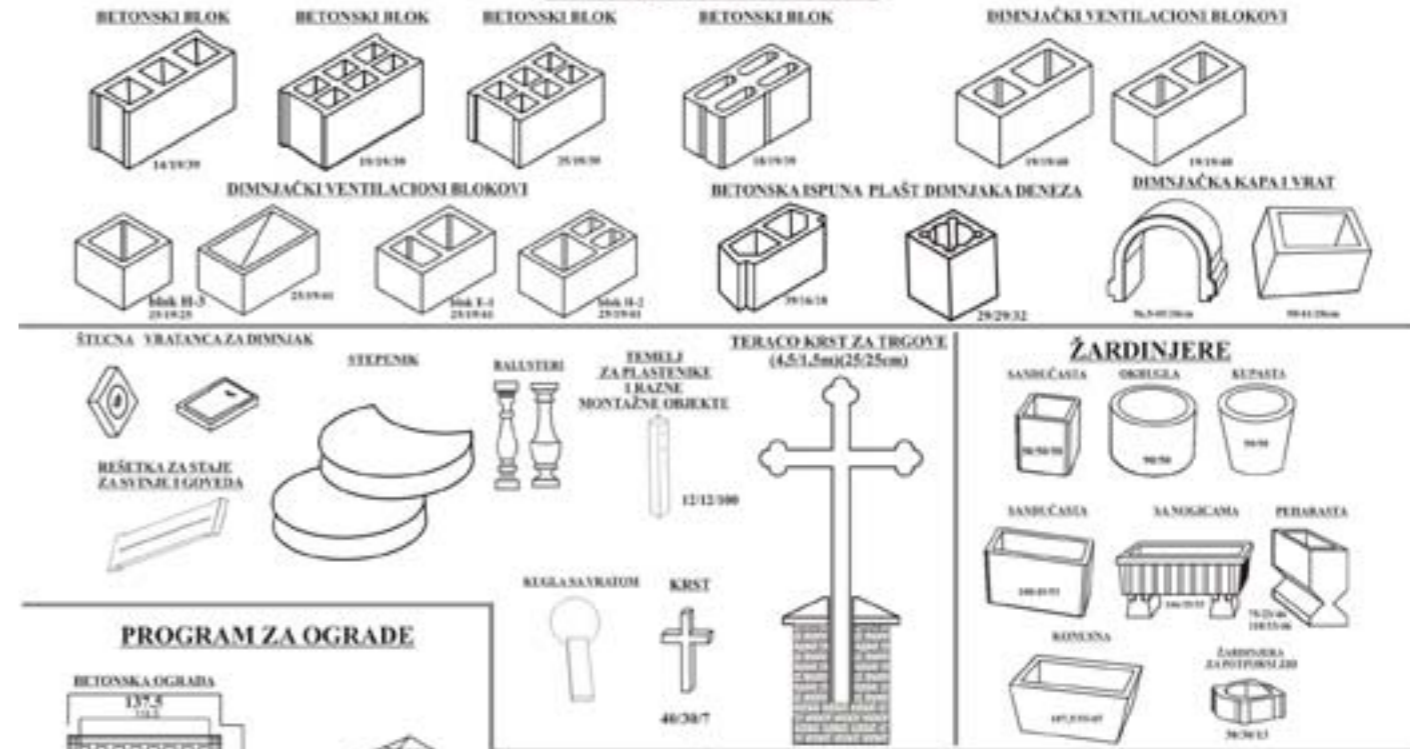

PARKOVSKI PROGRAM



Pogon I
NOVI SAD
(SREMSKA KAMENICA)
Senja Marinković 2a
Telefon: +381 21 464 174
Fax: +381 21 462 255
Mobilni: +381 62 6000 64



Pogon II
BEOGRAD
(PEČINCI)
Škoška 53
Fax: +381 21 462 255
Mobilni: +381 62 6000 64

EXCLUSIVE



1



2



4

VEŠTAČKI KAMEN
LAKI STONE

PRIGODAN
IZ OGLEDA

ZA VORASNOJI
SPOLJA I UNUTRA

VARIACIJE
U BOJAMA I TEKSTURAMA



IZVOĐENJE
GRADEVINSKIH
RADOVA

EXCLUSIVE



**VEŠTAČKI KAMEN
LAKI STONE**

POKROVANJE
IZ OULI

ZA UGRADNJE
SPOJNE I UNUTRA

VARIJACIJE
U BOJAMA I TEKSTURAMA



ATELJE INTARZIJA

UNIKATNI PROGRAM "SREMAC"



ATELJE INTARZIJA

UNIKATNI PROGRAM "SREMAC"

UNIKATNI PROGRAM "SREMAC"
UNIKA ROŠTILJA, KANTI, ŽARDINJERA...
UKRAŠAVANJE RUČNO SEČENIM
KOMADIĆIMA BIBER CREPA (MOZAIK).
MOGUĆI MOZAIKI I OD KAMENA



ateljeintarzija@gmail.com
+381 62 6000 64

EXCLUSIVE

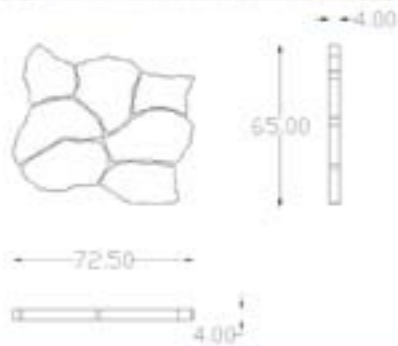

ŠVEDSKI SLOG



EXCLUSIVE

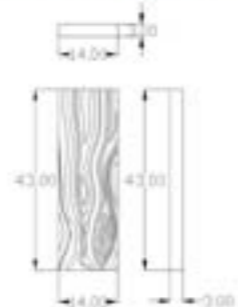

LIVENA DASKA

ELEMENTI BETON-GUMA

Elementi beton-guma namenjeni za privatne objekte, dečija igrališta, vrtiče, sportske terene, bolnice... Prednosti beton guma obloga: elastične sa potrebnom čvrstoćom, nisu toksične, otporne na habanje, ne klize, vodootporne, dugovečne, smanjuju opasnost od povreda i ozleda pri padu...

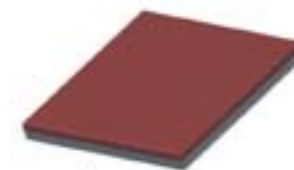

PLOČE BETON-GUMA
50/50 d-4+3 cm



IVIČNJAK BETON-GUMA
50/10/10

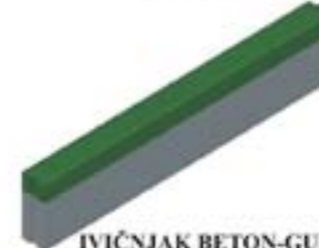

IVIČNJAK BETON-GUMA
100/8/20



GAZIŠTE 126/33/7
BETON-GUMA

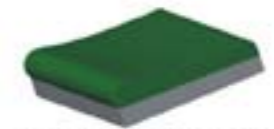

BAZENSKI ELEMENT
BETON-GUMA

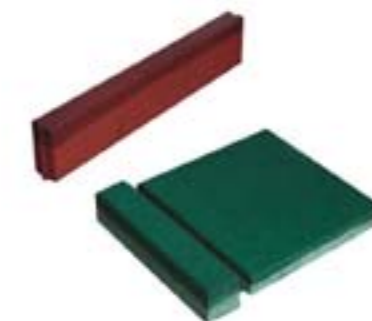



BEHATON

PRESOVANI PROGRAM

OLIMPIJA

PRESOVANI PROGRAM

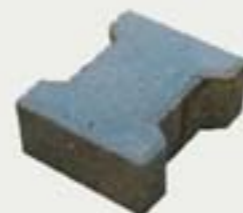
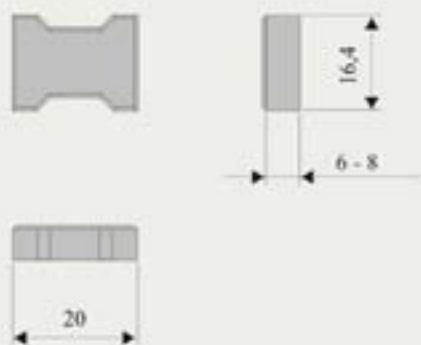

Potrošnja
35 kom/m²

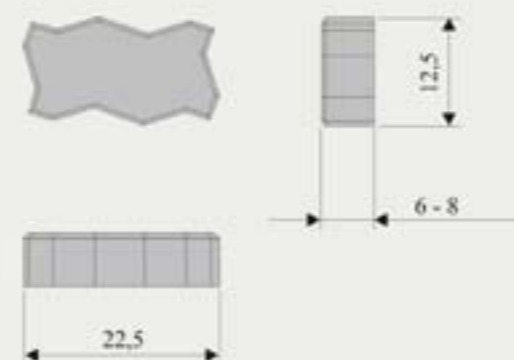

Potrošnja
40 kom/m²



REKET

PRESOVANI PROGRAM

LEPEZA

PRESOVANI PROGRAM

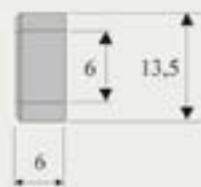

Potrošnja

38 kom/m²

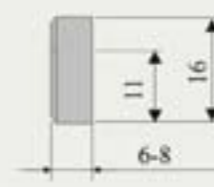

Potrošnja

41 kom/m²

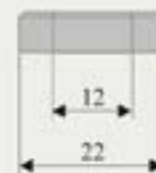

PLOČE 10x10 10x20 20x20 20x30 30x30



1



2

14 16:37

3



1

Potrošnja

PRESOVANI PROGRAM

10x10 - 100 kom/m²

10x20 - 50 kom/m²

20x20 - 25 kom/m²

20x30 - 16.5 kom/m²

30x30 - 11 kom/m²

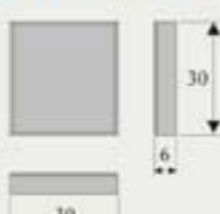
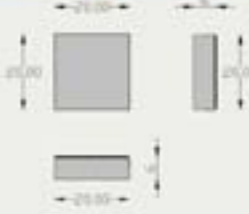
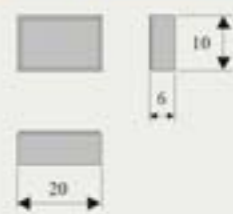
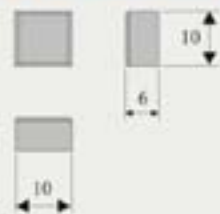

2

3



RUSTIK



Dimenzije

PRESOVANI PROGRAM

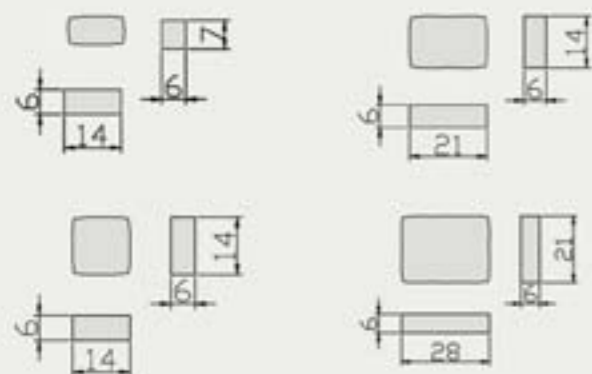



**PETROVARADIN
CIGLA**

PRESOVANI PROGRAM

**MEBA
RASTER**

PRESOVANI PROGRAM

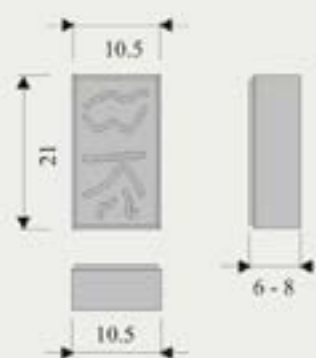

Potrošnja

43 kom/m²

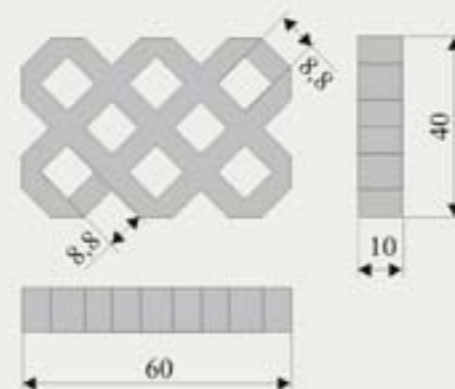

Potrošnja

4 kom/m²



KANALETE

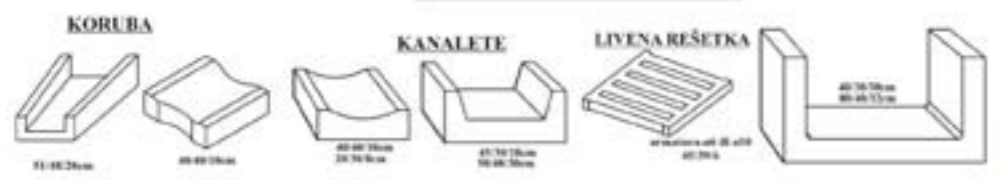

Potrošnja
45/18,30 - 3,3 kom/m
40/40/10 - 2,5 kom/m
30/20/5 - 3,3 kom/m

PRESOVANI PROGRAM



SAČE III

LIVENI PROGRAM

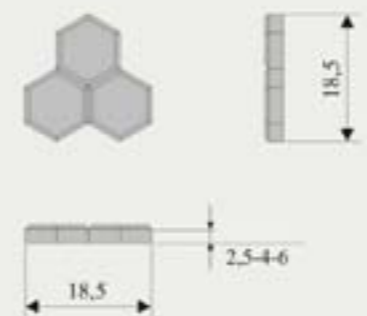
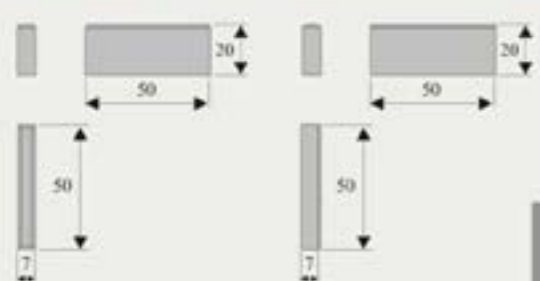

Potrošnja
44 kom/m ²

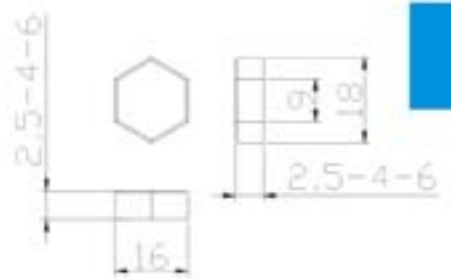

SAĆE I



Potrošnja
42 kom/m²

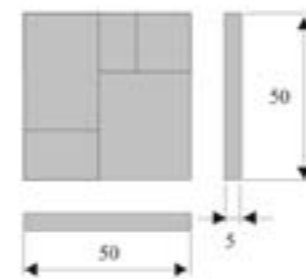

Potrošnja
4 kom/m²

BAROK **LIVENI PROGRAM**

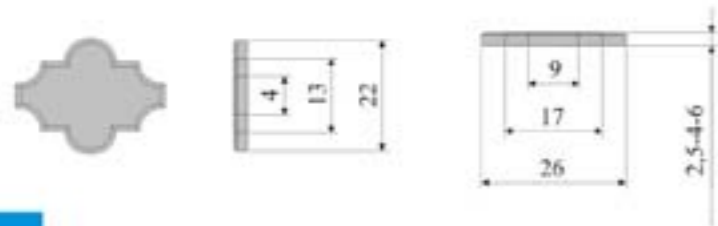

Potrošnja
28 kom/m²

PLOČA SUZA

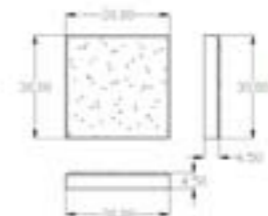

Potrošnja
11 kom/m²



LIVENI
IVIČNJACI

LIVENI PROGRAM

KANALETE

LIVENI PROGRAM

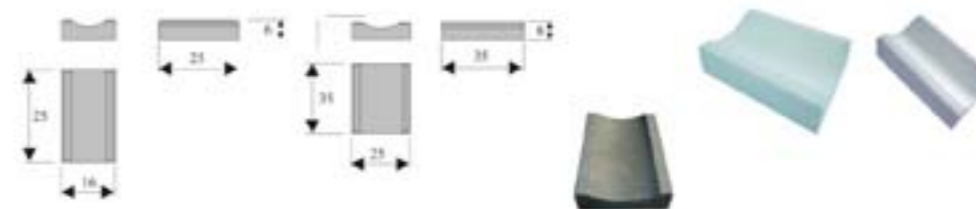
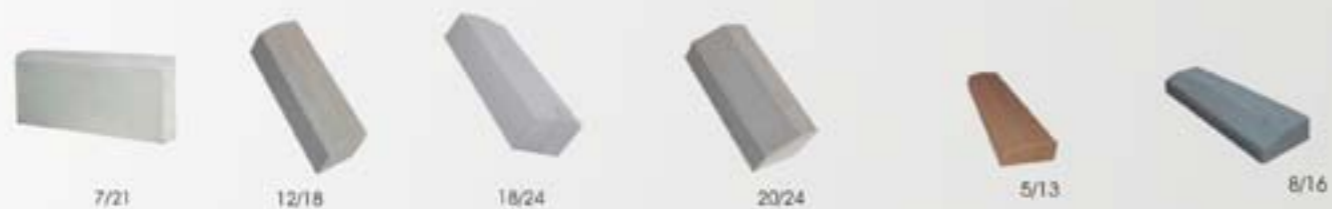

Potrošnja
25/16/6 - 4 kom/m²
35/25/8 - 3 kom/m²

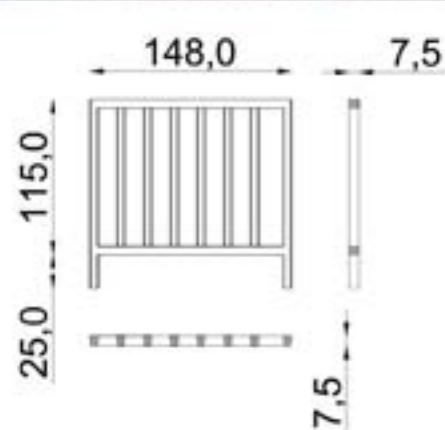

LIVENA OGRADA h=140

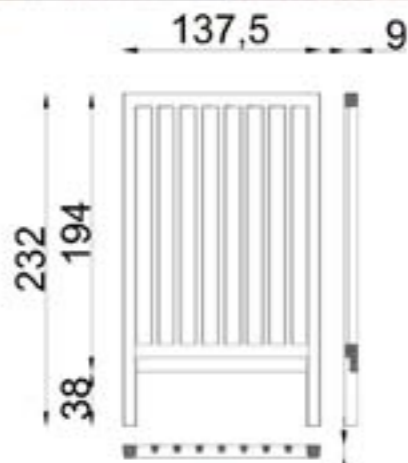

LIVENA OGRADA TIP SPENS

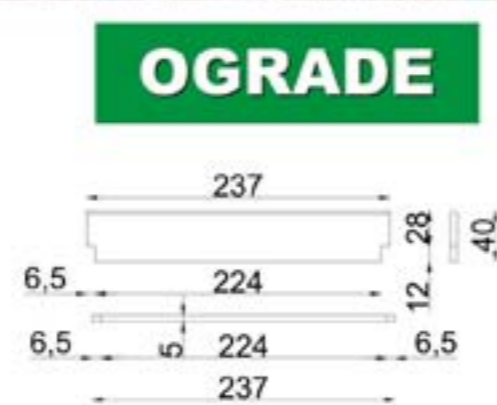

LIVENA ZIDNA PLATNA

OGRADE



JAVNE POVRŠINE

LIVENI PROGRAM



KRST



ŽARDINJERE

PARKOVSKI PROGRAM

SANĐUČASTA



SA NOGICAMA

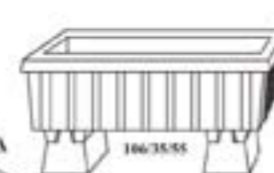

KONUSNA



PEHARASTA



KUPASTA



OKRUGLA



SANĐUČASTA





**POTPORNE
ŽARDINJERE**

PARKOVSKI PROGRAM

**ŽARDINJERA
ZA POTPORNI ZID**

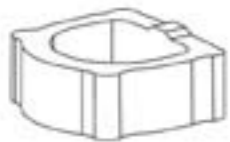

30/30/13

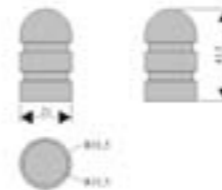

**KUGLA
ZA
PARKING**

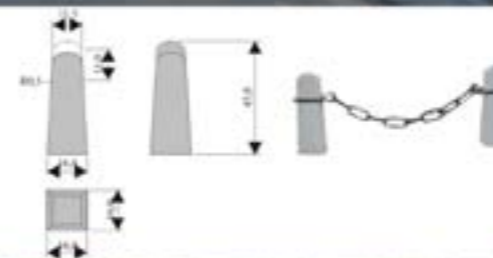

**PARKOVSKI
PROGRAM**

**ZAŠTITNI
STUBIČI**



**PARKING
KUGLA
SA VRATOM**

KLUPE, ČESME, KANTE... PARKOVSKI PROGRAM



ROŠTILJI



ERA 200



ERA 130



ERA 90



PERA 60



PERA 50



PEČNICA





tel/fax +381 21 462 255, 464 174;
mob. 062/6000-64



NOVI SAD-POGON I, CENTRALA
(SREMSKA KAMENICA)
Sonje Marinković 2a

NOVI SAD
(VETERNIK)
Futoški put 103

NOVI SAD
(LEDINCI)

NOVI SAD
(TEMERIN)

BEOGRAD-POGON II
(PEČINCI)
Školska 53

KIKINDA
STOVARIŠTE JOLIĆ
Bašaidski drum bb

ZEMUN
DENTING
Mačvanska 12

IZLOŽBENI PANOI

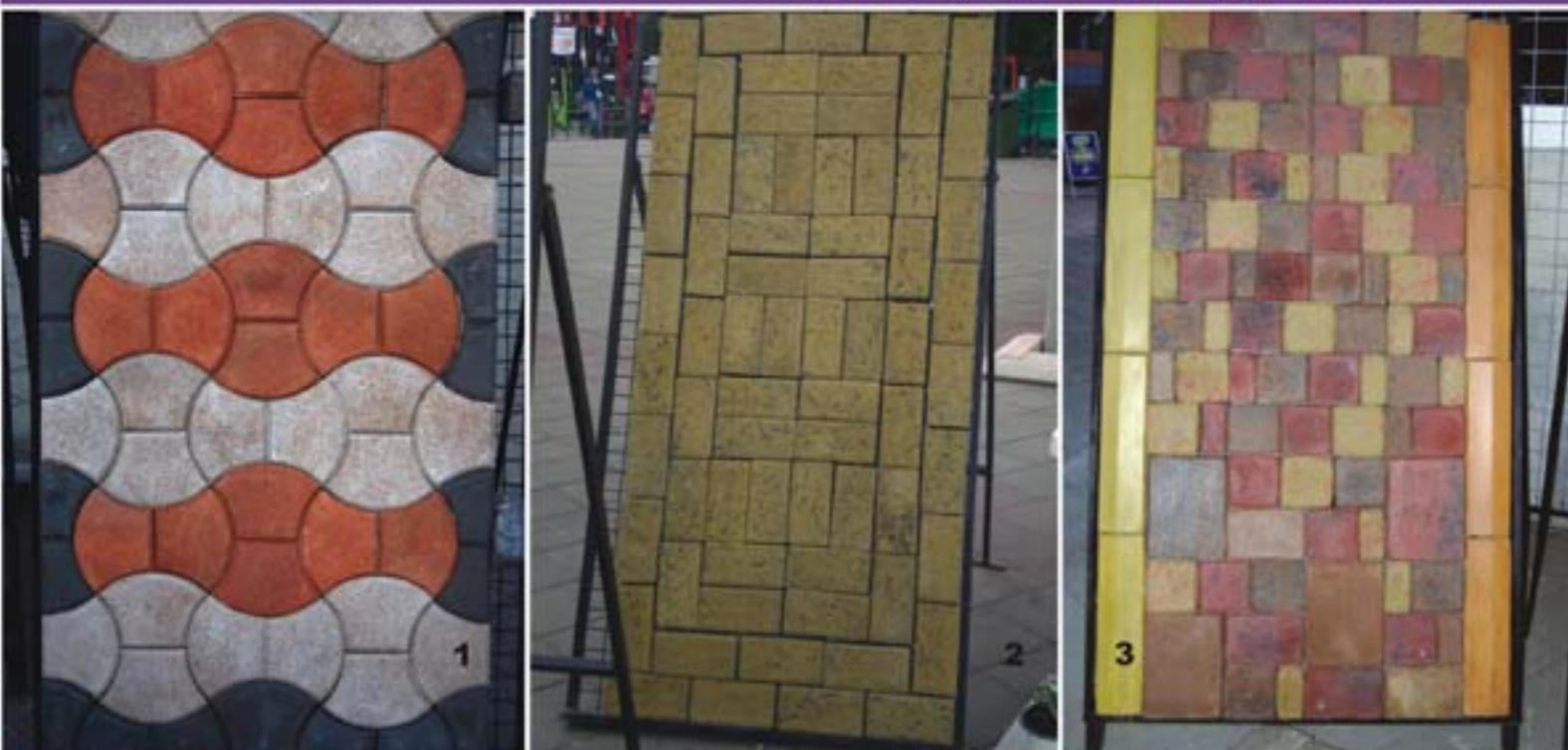

IZLOŽBENI PANOI

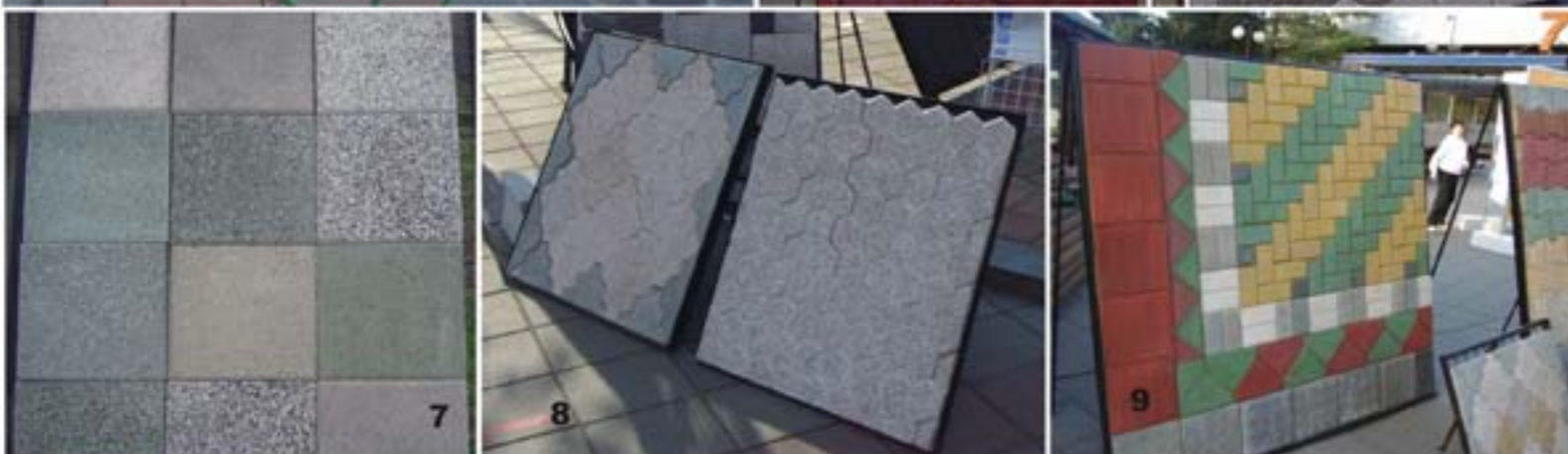



DRVENE KUĆE



DRVENE KUĆE





IZNAJMLJIVANJE GRADEVINSKIH MAŠINA

VIBRO ŽABE...100, 150, 300...600kg

VALJAK...2t

MEŠALICE 130l, 300l...HORIZONTALNE

VIBRO LETVE

VIBRO IGLE

HELIKOPTERI

MAŠINE ZA BRUŠENJE TERACA

CIRKULAR

KOMPRESORI

VILJUŠKARI...



Valjci, vibro ploče, vibro igle, vibro letve, vibro stolovi, vibro motori, helikopteri, delovi za viljuškare, mešalice, kalupi, mehanički secko, tamperi. Sva oprema za obradu betona I ugradnju prefabrikovanih betonskih elemenata za niskogradnju I visokogradnju.

Prese za proizvodnju betonske galanterije, kao I kompletne linije. Transportne trake vage. Projektovanje, trgovina I montaža kompletnih sistema. Izrada alata za sve tipove mašina...



**SEČENJE VODENIM MLAZOM
 WATER JET CUTTING**

 e-mail: office@aquarez.rs
 web: www.aquarez.rs

 Rešetke za
 water jet
 mašine

MLAZOM DO CILJA

Nudimo vam usluge sečenja:

- svih vrsta čelika: hladno valjani čelici, toplo valjani čelici, hardox, legurisane čelike...
- inox, bakar, aluminijum, aluminijumska saća, mesing, titanijum...
- sve vrste keramika (keramičke pločice, izrada intarzija, listela, mozaika, isecanje raznih motiva, oblika, u vidu slobodne forme u arhitekturi i građevinarstvu, kao i skraćivanje pločica na meru)
- granit, mermer, beton,
- staklo (ogledalo), plesiglas, plastika, klirit, teadit, drvo, iverica, lesonit, meki sunđeri, karton,

AKVATERM

 ПРОЈЕКТОВАЊЕ И ИЗВОЂЕЊЕ ЗАЛИВНИХ СИСТЕМА, БАЗЕНА
 ИНСТАЛАЦИЈЕ И ОПРЕМА ВОДОВОДА, ГРЕЈАЊА-ГАСА

- фонтане
- заливни системи
- базени
- кућне инсталације водовода и грејања
- гасне инсталације



Каћ, Добровољачка 58

Tel: 021/6212-151 Tel/ Faks: 021/6337-177 021/6337-107

e-mail: akvaterm@nscable.net akvaterm@neobee.net

Жиро рачун: 355-1043122-79 PIB: 102736206





UREĐENJE ZELENIH POVRŠINA



Na obroncima Fruške Gore, u blizini ledinačkog jezera

PATKE
ĆURKE
KOZE
GUSKE
KOKOŠKE

ŽIVINA
MESO
JAJA

PRIRODNO ZDRAVO

MOGUĆNOST ISPORUKE

KOZIJI PROIZVODI
SIR
MLEKO
SURUTKA
JARIĆI



064 129 55 23

**OSNOVANO 1998. GODINE.
TRGOVINA GRAĐEVINSKIM MATERIJALOM**

ASORTIMAN ROBE:

REZANA GRAĐA

ARMATURA

FERT GREDICE

CREP, CIGLA, BLOKOVI...

KERAMIČKE PLOČICE

SALONIT PLOČE

ONDULIN PLOČE

TEGOLA

BETONSKA GALANTERIJA

BRODSKI POD, LAMPERIJA...

CEMENT, KREČ, MULTIBAT

HIDROIZOLACIJA

TERMO IZOLACIJA-STIROPORI, MINERALNA VUNA...



GRAĐEVINSKI MATERIJAL OD TEMELJA DO KROVA



PRONAĐITE SREĆU! DOBRO DOŠLI!

- U NOVOM SADU:**
- ★ Braće Ribnikar 8
 - ★ Sentandrejski put BB
 - ★ Bul. Oslobođenja 65
 - ★ Jevrejska 35
 - ★ Bul. Oslobođenja 27
 - ★ Sutjeska 2
 - ★ Fruškogorska 20
 - ★ Bul. Oslobođenja 46
 - ★ Temerinska 34



**Slot Club
Sportska Kladionica**



BAZENSKI ELEMENTI

konusni

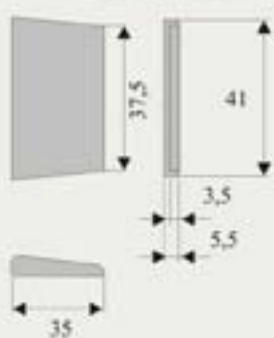

ravni

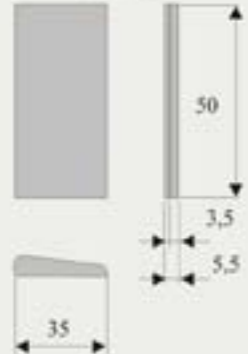

ugaoni

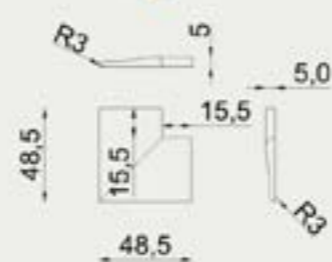

probst
the better solution

PRODAJA I DISTRIBUCIJA
ALATA ZA UGRADNJU
PREFABRIKOVANIH BETONSKIH ELEMENATA



tel/fax 021/462-255
mob.062/6000-64

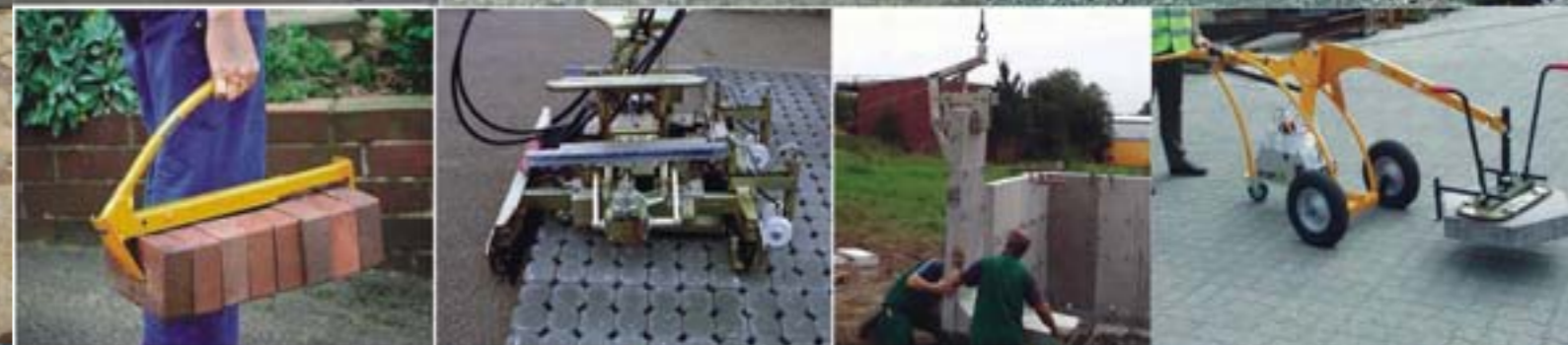



Pigoin I
NOVI SAD
 (SREMSKA KAMENICA)
 Sonje Marinković 2a
 Telefon: +381 21 464 174
 Fax: +381 21 462 255
 Mobilni: +381 62 6000 64



Pigoin II
BEOGRAD
 (PEČENCI)
 Školska 53
 Telefon: +381 22 85 324
 Fax: +381 21 462 255
 Mobilni: +381 62 6000 64



PROIZVODNJA
 BETONSKE GALANTERIJE
 I
 TRGOVINA
 GRADEVINSKOM OPREMOM

ROKOSKOC OVDJE BILTENA IMA PRAVO NA POPUST
 U ZAVISNOSTI OD TIPA I KOLIČINE NARUČENE ROBE
 DO 30%

AKCIJA VAŽI DO 30.06.2011.

office@dekra-s.rs
 www.dekra-s.rs

Upravište:
 BEOGRAD, Pečenci
 Školska 53

Proizvodnja i trgovina betonske galanterije i građevinske opreme. Kontakt: +381 22 85 324, +381 21 462 255, +381 62 6000 64. www.dekra-s.rs